

## MANUFACTURER'S WARRANTY

### WHAT IS COVERED:

Manufacturer warrants TO THE ORIGINAL PURCHASER ONLY that each item of equipment manufactured is free from defects in material and workmanship under normal use and service. Manufacturer's obligation under this warranty shall be limited to repair or replacement, at our plant, of any parts of the equipment which shall, within one year of the date of shipment to the original purchaser, be demonstrated to be defective. The original purchaser may obtain repair or replacement of the equipment under this warranty by returning the defective item or entire vendor to the Manufacturer, freight prepaid.

### WHAT IS NOT COVERED:

Manufacturer's warranty obligations DO NOT EXTEND TO OR INCLUDE installation expenses, vandalism, or difficulties resulting from failure to operate equipment in accordance with Manufacturer's instructions under competent supervision and difficulties due to changes in vended products which are beyond the control of Manufacturer.

**SPECIAL NOTE:** Manufacturer is not responsible for any loss of income due to a vending machine being out of service due to a warrantable item.

This warranty is in lieu of all other warranties, expressed or implied, including the warranty of merchantability and fitness or use, and of all other obligations or liabilities on Manufacturer's part. Manufacturer neither assumes, nor authorizes any other person to assume for it, any other liability in connection with the sale of equipment manufactured by itself. This warranty shall not apply to equipment manufactured or any part thereof which is subject to accident, negligence, alteration, abuse, misuse or damage in shipment. The term "original purchaser," as used in this warranty, shall be deemed to mean that person for whom the equipment is originally installed.

Manufacturer is not liable for any incidental, consequential or other damages of any kind whatsoever, directly or indirectly, arising from the use of the equipment whether based upon theories of contract negligence or tort.

Effective 9/01



CA11

11 Column



Operator's Manual

## **INTRODUCTION**

Congratulations on the purchase of your new Snack Vendor. This Snack Vendor has been designed to give you many years of dependable service. It requires little maintenance and is easy to set up and operate.

## **READ THIS MANUAL COMPLETELY**

Your Snack Vendor is designed to operate simply and reliably, but to take full advantage of your vendor, please read this owner's manual thoroughly. It contains important information regarding installation and operations, as well as a brief troubleshooting guide.

## **EQUIPMENT INSPECTION**

After you have received your Snack Vendor and have it out of the box, place it on a secure surface for further inspection. **Note:** Any damages that may have occurred during shipping must be reported to the delivery carrier immediately. Reporting damages and the seeking of restitution is the responsibility of the equipment owner. The factory is willing to assist you in this process in any way possible. Feel free to contact our Customer Care Department with any questions you may have on this process. It is important that you keep the original packaging for your vending machine at least through the warranty period. If your machine needs to be returned for repair, you may have to purchase this packaging if it is not retained.

Once you have your vendor located, we suggest that you keep this manual for future reference, or you can view this manual online at [seagamfg.com](http://seagamfg.com). Should any problems occur, refer to the section entitled "COMMON QUESTIONS AND ANSWERS". It is designed to help you quickly identify a problem and correct it.

### **For Technical Support & Service**

#### **Contact our Customer Care Dept.**

8:30 a.m. - 4:00 p.m. CST. Mon thru Fri

815.297.9500 ext 160

815.297.1758 Fax

email: [customercare@seagamfg.com](mailto:customercare@seagamfg.com)

### **For Parts**

#### **Contact our Parts Dept.**

8:30 a.m. - 4:00 p.m. CST. Mon thru Fri

815.297.9500 ext 160

815.297.1758 Fax

email: [parts@seagamfg.com](mailto:parts@seagamfg.com)



700 Seaga Drive  
Freeport, IL 61032 U.S.A.  
**Online:** [seagamfg.com](http://seagamfg.com)

Figure 13 Optional \$.80 configuration

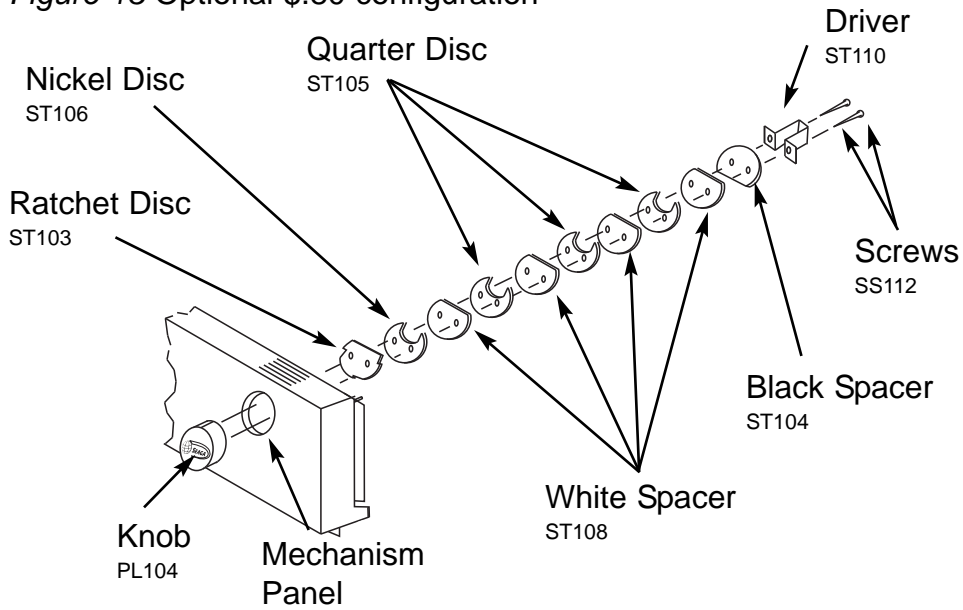
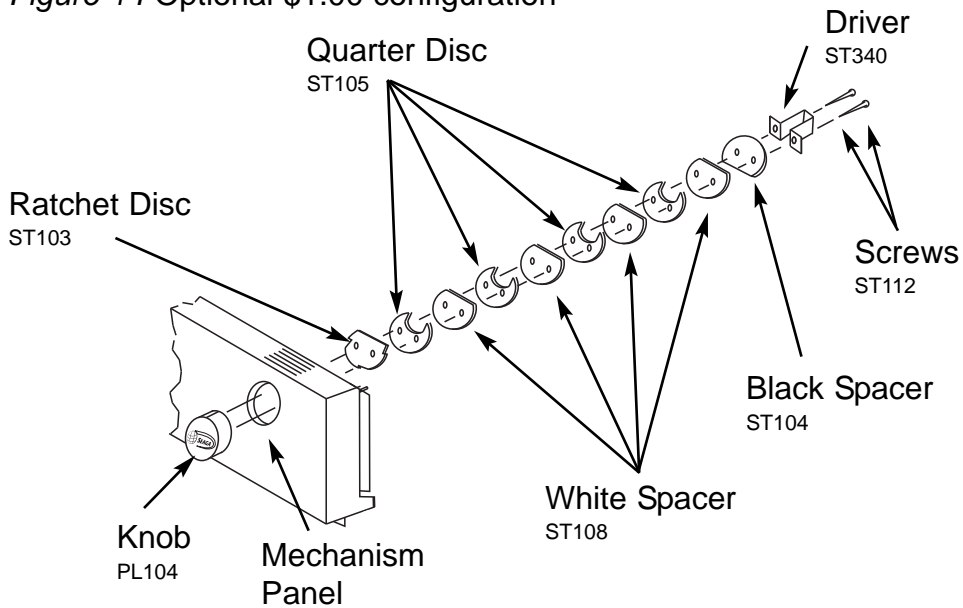
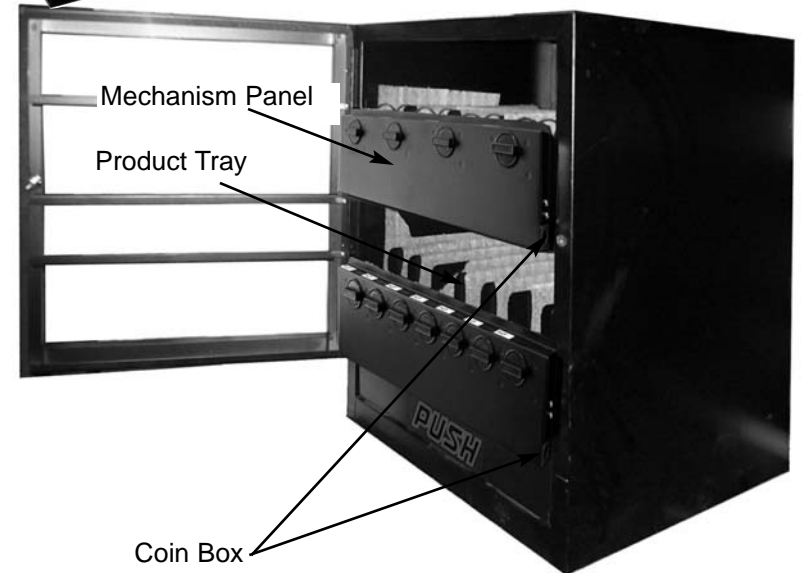

Figure 14 Optional \$1.00 configuration



**CA11**  
**11 Column**  
**Mechanical**  
**Snack Vendor**



### LOCKS

Your CA11 Vendor has one (1) screw type Lock. To unlock the Front Door, unscrew the Lock counter clockwise until the door is free. To lock, apply firm pressure below the Lock as you tighten the Lock. Do not over tighten as you could ruin the seal. You will be able to remove the key, only when the key is vertical or horizontal.

### DELIVERY SYSTEM

Your new CA11 features a rear-drop delivery system to prevent theft. The CA11 delivery system is made up of three (3) components, the Product Tray, the Helix Coils, and the Coin Mechanism (Fig. 1). Once the proper amount of coins is received the Coin Mechanism drives the Helix Coil and pushes the product out the back of the Product Tray.

Figure 1 Delivery System

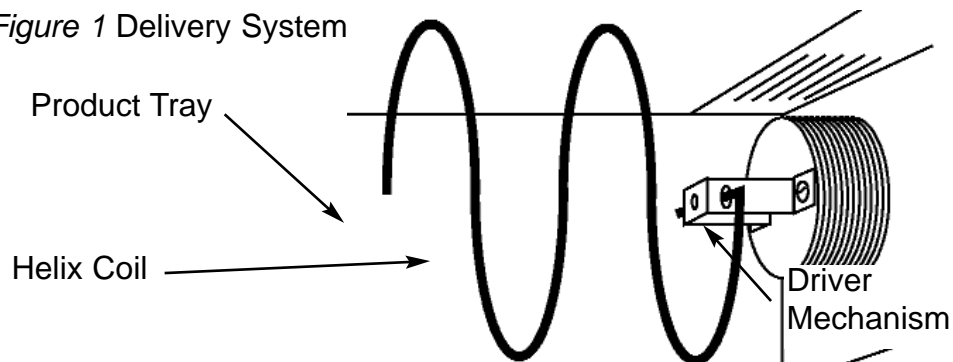

Figure 11 Optional \$.70 configuration

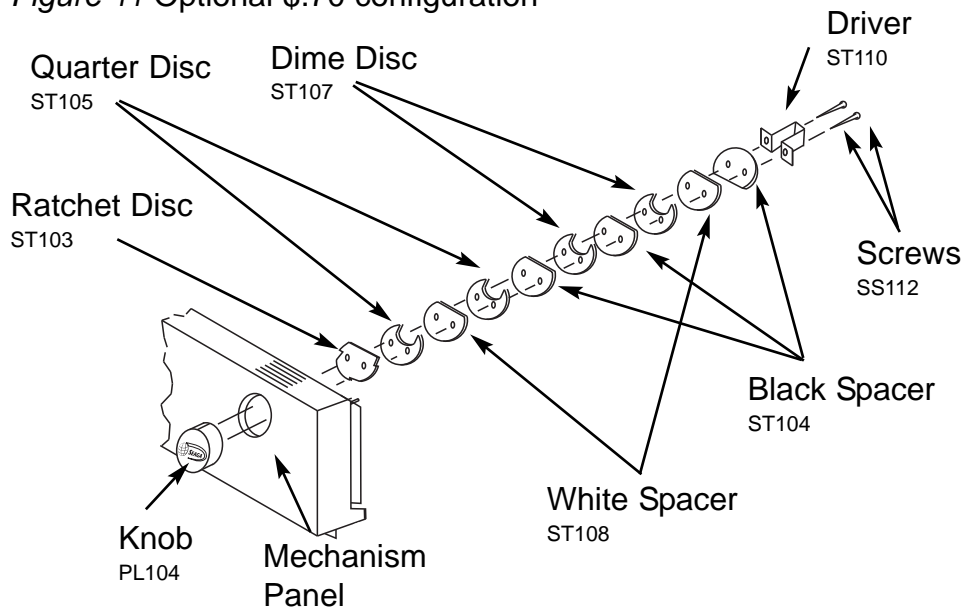

Figure 12 Optional \$.75 configuration

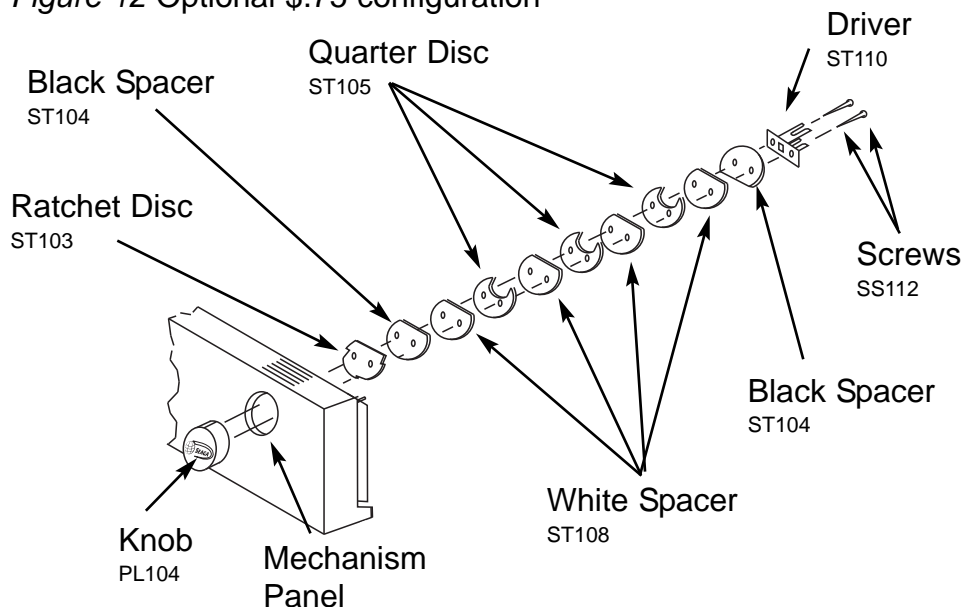

Figure 9 Optional \$.60 configuration

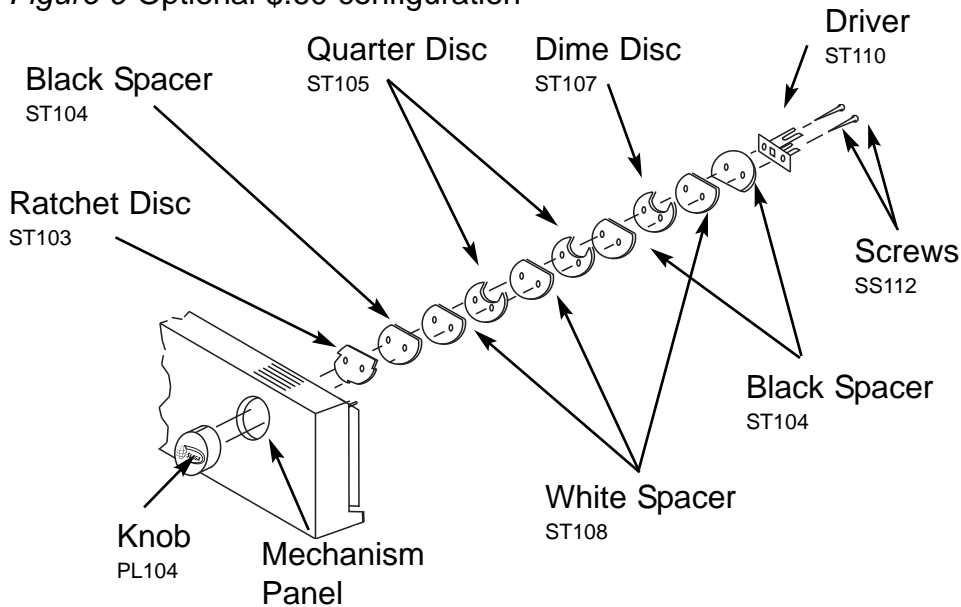
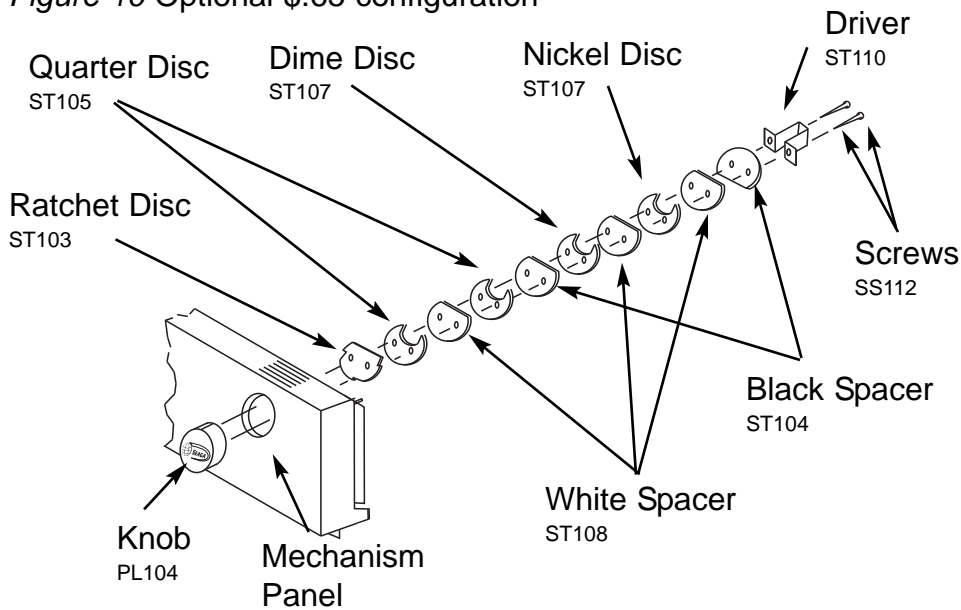

Figure 10 Optional \$.65 configuration



**DRIVER MECHANISM**

The Mechanism Panels are the front upper and lower panels. These panels control the receiving of money and the action of the Helix Coil. Once the correct amount of money is received, the Mechanism Knob can be turned clockwise. Product is vended by turning the Mechanism Knob one (1) complete revolution.

The Driver Mechanism (Fig. 2) comes factory preset but can be changed to suit your needs. The Coin Sub-Assembly is made up of a series of discs consisting of white, black and metal Coin Discs. The white spacers are thinner than the black, and the combination of the two place the Coin Discs in the proper position to receive coins.

Figure 2 Driver Mechanism reference

All discs are the "Coin Sub-Assembly"

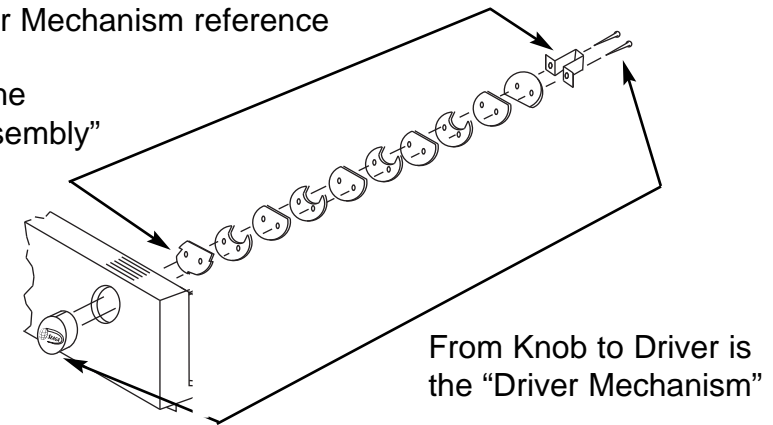

In some cases you will find all one (1) color of spacers. This is common in an all-quarter configuration. Contact our Customer Care Dept. for additional instructions on changing your Coin Sub-Assembly if necessary.

1. To access Coin Mechanism:

- A.) Unlock and remove Front Door.
- B.) Remove the Mechanism Panel by first removing the two (2) Silver Screws on both sides of the Mechanism Panel.
- C.) Pull the Mechanism Panel outward. Carefully free Drivers from all Helix Coils.
- D.) Turn desired Mechanism Knob clockwise ¼" turn and place Mechanism Panel face down on a flat surface, exposing the Driver Mechanism and "S" bracket assembly. (Fig. 3)

**Note:** Change one Driver Mechanism at a time.

- E.) To change Driver Mechanisms, remove two (2) nuts (Fig. 6) and gently remove "S" Bracket Assembly.
- F.) Unscrew and remove the two (2) Screws holding Driver to the Coin Sub-Assembly. (Fig. 3 & 4)

Figure 3 Inside view of Driver Mechanism

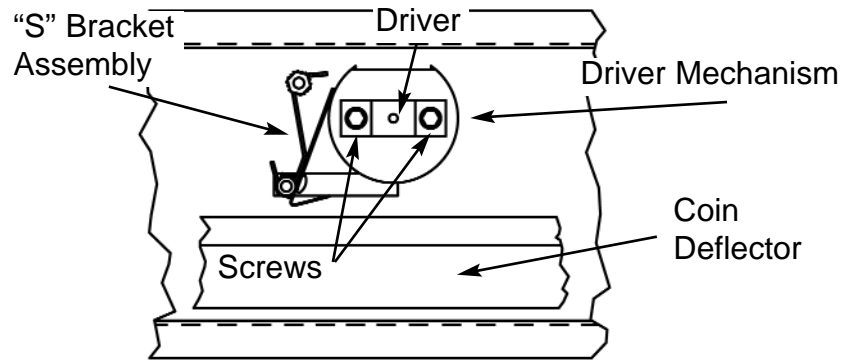

G.) Coin Sub-Assembly (Fig. 4) will come apart from Knob, and can be carefully removed.

2. To assemble Driver Mechanism:

- A.) Lubricate backside of Mechanism Panel around holes with a small amount of petroleum jelly.
- B.) Insert two (2) screws through Coin Sub-Assembly to Knob. Make sure Knob is seated properly and tighten screws into place. If handle is hard to turn, loosen the two (2) screws  $\frac{1}{8}$  to  $\frac{1}{4}$  turn.
- C.) Turn mechanism Knob to align Coin Discs with "S" bracket mounting studs. Install "S" bracket assembly over mounting studs. Do not install the nuts yet.
- D.) Now turn Mechanism Knob so Coin Disc slots are facing down. The Anti-Reverse Dog can now be raised enough to enable the

Figure 4 Driver Mechanism exploded view

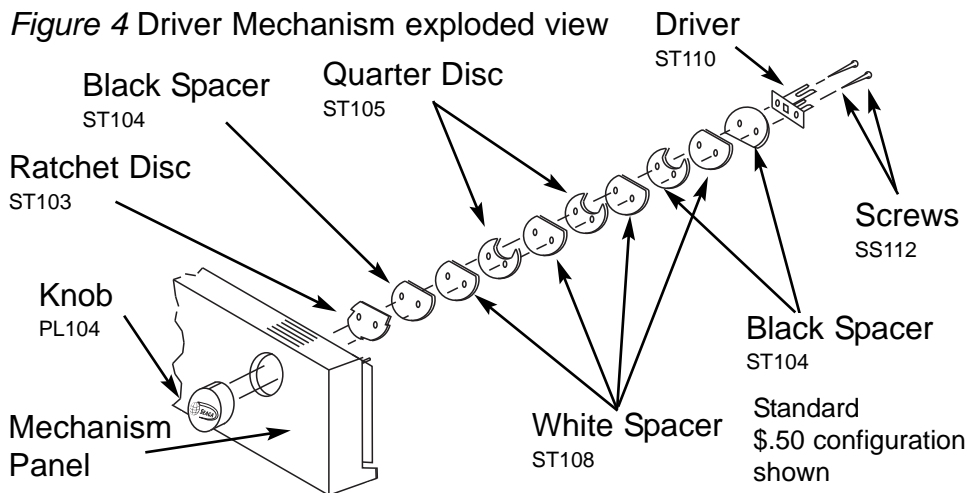

Figure 8 Coin Rejecter Fingers

Figure 9a Caught! Empty Coin Discs should catch on the center of the Coin Rejecter fingers.



Figure 9b Accepted! Coins should push the fingers out. Make sure coins contact the center of the fingers.

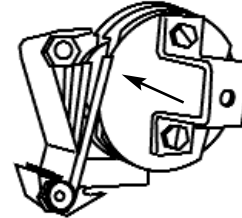

Figure 9c Vend! Accepted coins push the fingers over the Coin Discs' catches to vend.



Q: What can I use to clean the outside of my vendor?  
 A: A lint free rag and a mild window cleaner are recommended. Be sure however not to directly spray decals as the ink could run.

Q: How do I remove a Lock that won't open.  
 A: Drill into the center of the Lock with a 1/4" drill bit. The Lock should fall apart and be easily removed. Increase the bit size and try again if the Lock does not come out.

**NOTES**

screw threads. If this does not remedy the problem a replacement Knob may be needed.

Q: My mechanism rotates backward.

A: Your Knob should not do this. Remove the Mechanism Panel and check for proper placement and condition of the Anti-Reverse Dog.

Q: My mechanism rotates but product will not drop.

A: Check to see if the product is jammed in the Column.

Check to see if the vendor is level.

Check product for damage, and make sure it is the proper size.

Q: My knob turns ¼" turn and jams.

A: First remove your Mechanism Panel. Check the position of the coins to see if they are in-between the Coin Rejecter fingers. If this is the case, place a screwdriver in-between the Coin Rejecter and the discs and lift up freeing the Coin Rejecter. At this point the Driver Mechanism can now be rotated backwards. Reposition the Coin Rejecter fingers with your screwdriver to line up with coins and vend through. (Fig. 8)

### **GENERAL**

Q: Can customers reach up and help themselves to product?

A: No. The Vendor pushes product out the back of the Product Trays, also Product Door is a Triangle shape designed to deter reach up theft.

When pushed, the back of the door will come in contact with the bottom Product Tray to act as a block.

Q: My key won't turn my Lock to open.

A: Check to be sure that you are using the proper key. If the correct key is being used, your Lock may have been damaged or vandalized. Vandalism to locks is quite common. Having spare Locks in your toolbox at all times is recommended.

Figure 5 "S" Bracket Assembly

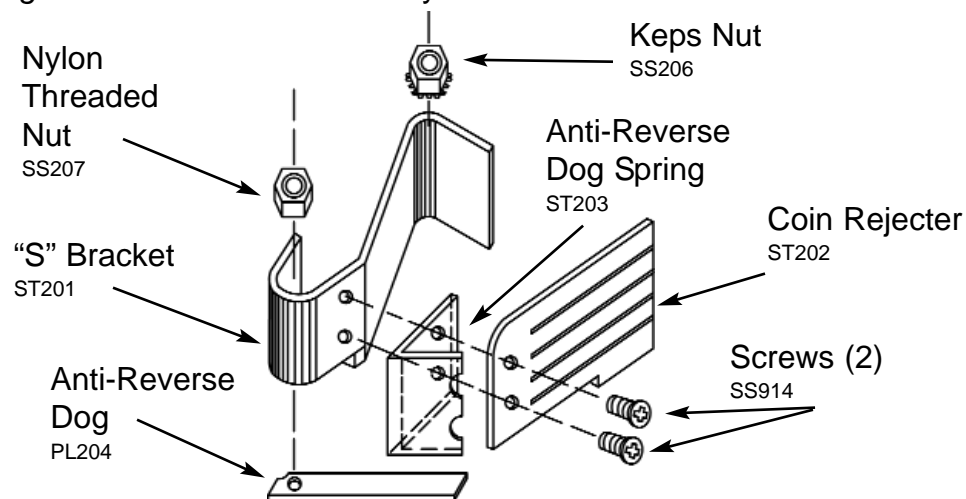

Anti-Reverse Dog Spring to seat under the Anti-Reverse Dog. At the same time the "S" bracket assembly will be seated against Mechanism Panel. Place Keps Nut on upper mounting stud. (DO NOT TIGHTEN NUTS.) (Fig. 3, Pg. 6 and Fig. 5)

E.) Turn Knob to align coin discs with "S" bracket assembly, once again. Use a screwdriver to push top of "S" bracket assembly fully to right and tighten Keps Nut. You may now tighten Nylon Threaded Nut to lower mounting stud. (DO NOT OVER TIGHTEN.)

**Note:** The fingers of the Coin Rejecter must align with Coin Discs of the Coin Sub-Assembly. The Coin Discs strike the center of each finger to prevent vending without coins. **This alignment is critical.** If the fingers are misaligned the vendor will not vend. (Fig 6)

F.) Check to see that "S" bracket assembly is firmly seated against Mechanism Panel and upper mounting stud. Check that Anti-Reverse Dog Spring is engaged on Anti-Reverse Dog. Make sure Anti-Reverse Dog moves freely and locks into Ratchet Disc as the mechanism is rotated counter-clockwise. If Anti-Reverse Dog does not move freely, loosen Nylon Threaded Nut on the lower mounting stud. If this does not help, remove "S" bracket assembly and close Anti-Reverse Dog Spring to put more pressure on Anti-Reverse Dog. Check that coin discs are properly aligned with the Coin Rejecter by inserting money through slots in the top of the Mechanism Panel. Make sure the Coin Rejecter is properly engaging the coin disc stops. (Improper alignment will allow coins to slip between slots in the Coin Rejecter.)

Refer to the optional mechanism configurations at the end of this manual. Always make sure your Driver Mechanism is built as specified in the diagram. **Note:** The disc next to the Driver is always placed upside down (the rounded side will be at the top of the disc only) to prevent coins from jamming the mechanism.

### Figure 6 Proper Finger Alignment

*Figure 6a Accepted!*  
Coins should push the fingers out. Make sure coins contact the center of the fingers.

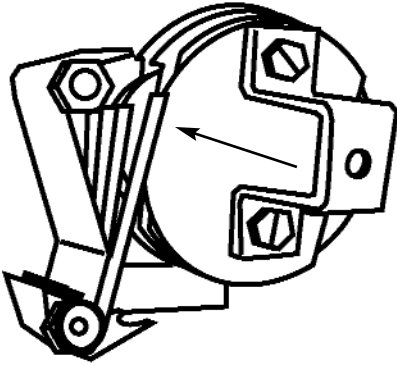

*Figure 6b Vend!*  
Accepted coins push the fingers over the Coin Discs' catches to vend.

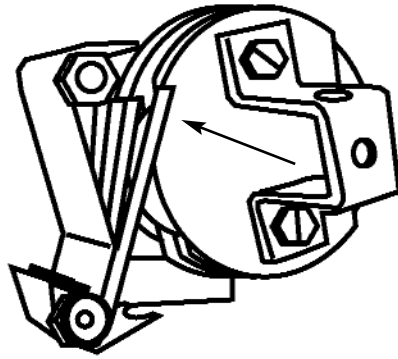

### LOADING PRODUCT

To present your product in as an attractive and professional manner as possible, do not load any damaged items, and make sure items are facing forward for easy identification by your customer.

**Note:** The size of the item being vended must be larger than the Helix Coil, but smaller than the Column, to vend correctly. Never force an oversized item into the Helix Coil or Column, nor attempt to vend an item that is smaller than the Helix Coil as this will create problems and deter customers.

#### 1. To Load Product:

- A.) Pull desired Product Tray forward. **Note:** Pull out only one (1) Product Tray at a time.
- B.) Place product in proper size Helix Coil. Note: Bottom of product must rest on the Product Tray and not on the Helix Coil. (Fig.7) Load each Helix Coil from back to front. **Note:** Fill all Helix Coils fully, do not leave any empty spaces behind or between items. If you must leave empty space leave it in the front of the Tray closest to the Product Window.
- C.) Once Product Tray is fully loaded, lift and push it back in. Repeat above

### Figure 7 Loading Product



steps until both Product Trays are fully loaded.

**Special Note:** We suggest that you always partially fill the vendor with product and perform at least five (5) test vends.

### COIN RETRIEVAL

Two (2) Coin Boxes are provided with your CA11. They are stored inside the Mechanism Panel directly below the Coin Mechanisms. Once the Front Door is open pull the Coin Boxes out to the right to empty them.

### GENERAL NOTES

It is suggested that a tool box accompany you to each of your locations. Suggested items for this tool box would include a socket set, (up to a 1/2" socket size suggested) a Phillips and a Standard screwdriver. Additional items would be a small jar of Petroleum Jelly (Vaseline), a small brush for applying the Petroleum Jelly, a soft rag and perhaps a Black Magic marker. The magic marker is useful in touching up light scratches that may occur to your vendor.

### COMMON QUESTIONS AND ANSWERS

#### MAINTENANCE

- Q: My knob turns without coins.  
A: Your Coin Rejecter is loose, misaligned or broken. Refer to the Driver Mechanism section of this manual for proper placement of the Coin Rejecter. (See Fig. 5 & Fig. 8)
- Q: My mechanism screws keep coming loose.  
A: Remove Mechanism Panel. Disassemble Knob. Apply lock tight to Knob